

IXIO-D01 I

OPENING & PRESENCE SENSOR FOR AUTOMATIC INDUSTRIAL DOORS

User's Guide for software version 0501 and higher
(refer to tracking label on product)



Download the BEA DECODER app for a quick overview of settings



DESCRIPTION

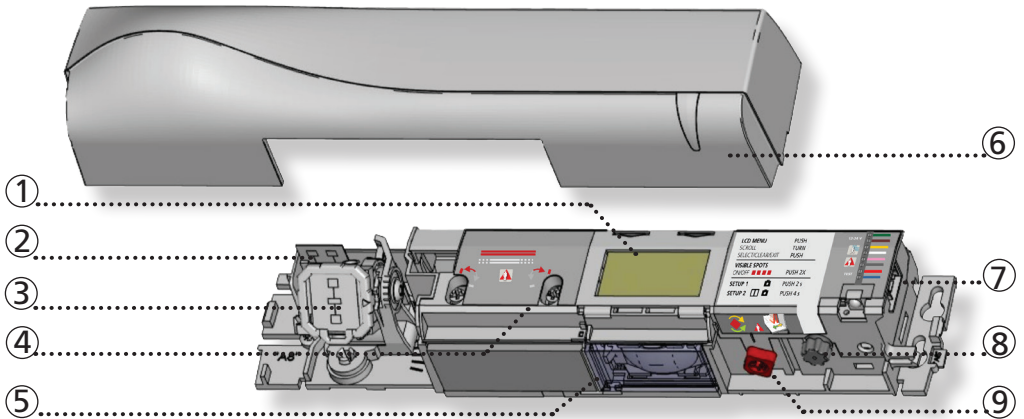

- | | | | |
|----|------------------------------|----|----------------------------------|
| 1. | LCD | 6. | cover |
| 2. | radar antenna (narrow field) | 7. | main connector |
| 3. | radar antenna (wide field) | 8. | main adjustment knob |
| 4. | IR-curtain width adjustment | 9. | IR-curtain angle adjustment knob |
| 5. | IR-lenses | | |

ACCESSORIES



BA: Bracket accessory



CA: Ceiling accessory

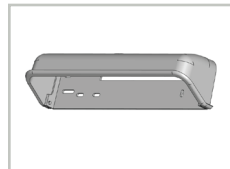

RA: Rain accessory

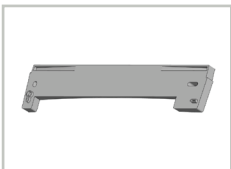

CDA: Curved door accessory



9 V battery

HOW TO USE THE LCD?

DISPLAY DURING NORMAL FUNCTIONING

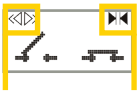

Opening impulse

Safety



Negative display = active output



To adjust contrast, push and turn the grey button simultaneously.

During normal function only.

FACTORY VALUE VS. SAVED VALUE

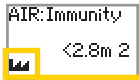

displayed value = factory value



displayed value = saved value

NAVIGATING IN MENUS



Push to enter the LCD-menu



Enter password if necessary

Not during the first minute after power-on of the sensor.



Select your language before entering the first LCD-menu.

During the first 30 seconds after power-on of the sensor or later in the diagnostics menu.



Scroll menu items



Select **Back** to return to previous menu or display.



Select **More** to go to next level:

- basic settings
- advanced settings
- diagnostics

CHANGING A VALUE



Scroll menu up-down



Push to select parameter



current value is displayed



Scroll values up-down

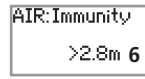

more values are displayed



Push to save new value



new value is displayed

CHANGING A ZIP CODE



See application note on ZIP CODE



...

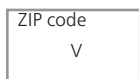
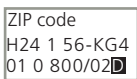

Validate the last digit in order to activate the new ZIP code:

- v = valid ZIP code, values will be changed accordingly
- x = invalid ZIP code, no values will be changed
- v/x = valid ZIP code, but from a different product.

Only available values will be changed.

VALUE CHECK WITH REMOTE CONTROL



Pressing a parameter symbol on your remote control, displays the saved value directly on the LCD-screen.

Do not unlock first.

1 MOUNTING & WIRING

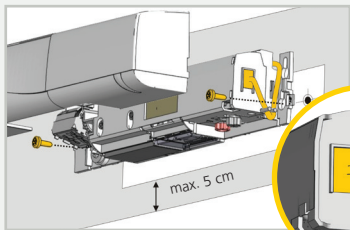

Fixation is compatible with the ACTIV8.



* Depending on OUTPUT CONFIGURATION settings



2 RADAR OPENING IMPULSE FIELD

ANGLE

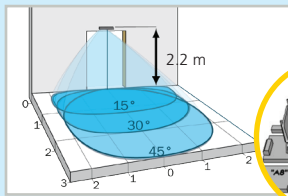

field size: 9
immunity: 2

from 15° to 45°, default 30°

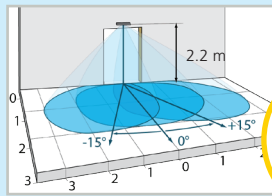

field size: 9
immunity: 2

from -15° to 15°, default 0°

WIDTH

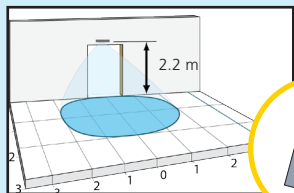

field size: 9
immunity: 2

4 m x 2 m (wide)

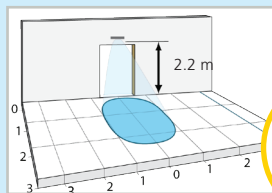

field size: 9
immunity: 2

2 m x 2.5 m (narrow)

The size of the detection field varies according to the mounting height of the sensor.

3 INFRARED SAFETY FIELD

ANGLE

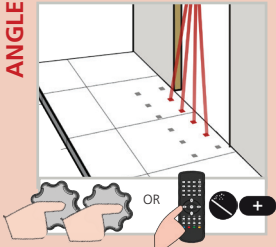

Activate the visible* spots to verify the position of the IR-curtain.

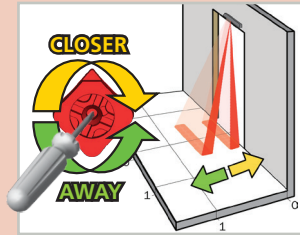

If necessary, adjust the IR-curtain angle (from -7° to 4° , default 0°).

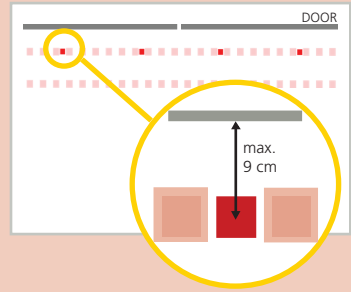

* Visibility depends on external conditions. When spots are not visible, use the Spotfinder to locate the curtains.

WIDTH

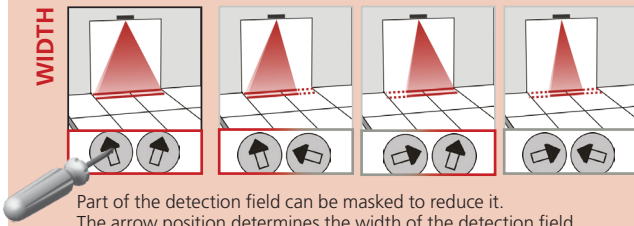

Part of the detection field can be masked to reduce it. The arrow position determines the width of the detection field.

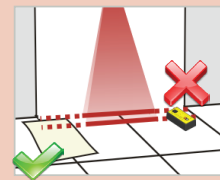

Always verify the actual detection field width with a piece of paper and not the Spotfinder, which detects the whole emitted field.

Additional adjustments are possible by LCD or remote control (see p. 5)

The size of the detection field varies according to the mounting height and the settings of the sensor. The full door width must be covered.

4 SETTINGS

Choose one of the following presets or adjust the sensor manually (see p.5):

STANDARD: standard in- and outdoor installations

CRITICAL ENVIRONMENT: critical installations due to surroundings or weather

SHOPPING STREET: installations in narrow streets with pedestrian traffic

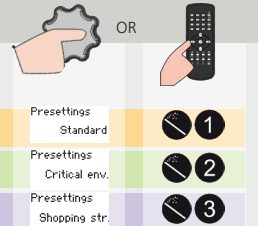

5 SETUP



STEP OUT OF THE INFRARED FIELD!

SETUP 1 (QUICK)

reference picture



SETUP 2 (ASSISTED)

test of full door cycle + reference picture



TEST THE GOOD FUNCTIONING OF THE INSTALLATION BEFORE LEAVING THE PREMISES!

OVERVIEW OF SETTINGS

BASIC



Back
More

PRESETTINGS

	0	1	2	3	4	5	6	7	8	9
PRESETTINGS		standard	critical env.	shopping street			factory values for radar immunity, IR immunity, IR number and redirection increased immunities, 1 curtain increased immunities, redirection = motion and presence			

RAD: FIELD SIZE

RAD: FIELD SIZE	small	>	>	>	>	>	>		>	large
-----------------	-------	---	---	---	---	---	---	--	---	-------

IR: IMMUNITY

IR: IMMUNITY		low	normal	high	higher	highest	normal	high		
--------------	--	-----	--------	------	--------	---------	--------	------	--	--

IR: FREQUENCY

IR: FREQUENCY		A	B	Sensors mounted close to each other should have a different frequency.						
---------------	--	---	---	--	--	--	--	--	--	--

More
Back

ADVANCED



Back
More

ADVANCED		factory value								
----------	--	---------------	--	--	--	--	--	--	--	--

RAD: IMMUNITY

RAD: IMMUNITY		low		>	>	>	>	>	>	high
---------------	--	-----	--	---	---	---	---	---	---	------

RAD: DIRECTION

RAD: DIRECTION		bi	uni	uni PRM	uni AWAY	bi shop	uni shop	PRM shop	PRM: for persons with reduced mobility AWAY: unidirectional motion away from sensor shop: automatic adaptation of field size (small shops)	
----------------	--	----	-----	---------	----------	---------	----------	----------	--	--

RAD: HOLD TIME

RAD: HOLD TIME	0.5 s	1 s	2 s	3 s	4 s	5 s	6 s	7 s	8 s	9 s
----------------	-------	-----	-----	-----	-----	-----	-----	-----	-----	-----

RAD: OUTPUT

RAD: OUTPUT		NO NC	NC NO	NC NC	NO NO		NO: normally open NC: normally closed		Inv.freq **	Inv.freq.: frequency in detection (2.5 Hz)
-------------	--	----------	----------	----------	----------	--	--	--	----------------	--

IR: WIDTH

IR: WIDTH											Always additionally adjust the arrow position on the sensor with a screwdriver.
-----------	--	--	--	--	--	--	--	--	--	--	---

IR: NUMBER

IR: NUMBER	service mode	1	2	service mode = no IR detection during 15 minutes (maintenance).						
------------	--------------	---	---	---	--	--	--	--	--	--

IR: PRESENCE TIME

IR: PRESENCE TIME	motion	15 s	30 s	1 min	2 min	5 min	10 min	20 min	60 min	infinite
-------------------	--------	------	------	-------	-------	-------	--------	--------	--------	----------

IR: OUTPUT

IR: OUTPUT		NO NC	NC NO	NC NC	NO NO		NO: normally open NC: normally closed			
------------	--	----------	----------	----------	----------	--	--	--	--	--

REDIRECTION

REDIRECTION	motion	motion or presence	motion and presence	opening output is active in case of:			0	motion detection motion or presence detection motion and presence detection		
-------------	--------	--------------------	---------------------	--------------------------------------	--	--	---	---	--	--

FACTORY RESET

FACTORY RESET		full reset	partial reset	partial: outputs are not reset						
---------------	--	------------	---------------	--------------------------------	--	--	--	--	--	--

More
Back

DIAGNOSTICS



ZIP CODE



all parameter settings in zipped format
(see application note on ZIP CODE)

ID

unique ID-number

ERROR LOG

last 10 errors + day indication

IR: SPOTVIEW

view of spot(s) that trigger detection

IR: C1 ENERG

signal amplitude received on curtain 1

IR: C2 ENERG

signal amplitude received on curtain 2

- POWERSUPPLY
- OPERATINGTIME
- RESET LOG
- PASSWORD
- LANGUAGE
- ADMIN

supply voltage at power connector
power duration since first startup
delete all saved errors
LCD and remote control password
(0000= no password)
language of LCD-menu
enter code to access admin mode

** Only accessible via LCD

TROUBLESHOOTING

E1 	ORANGE LED flashes 1 x.	The sensor signals an internal fault.	<ol style="list-style-type: none"> 1 Replace sensor.
E2 	ORANGE LED flashes 2 x.	The power supply is too low or too high.	<ol style="list-style-type: none"> 1 Check power supply (in the diagnostics menu of the LCD). 2 Check wiring.
E4 	ORANGE LED flashes 4 x.	The sensor receives not enough IR-energy.	<ol style="list-style-type: none"> 1 Decrease the angle of the IR-curtains. 2 Increase the IR-immunity filter (values >2.8 m). 3 Deactivate 1 curtain.
E5 	ORANGE LED flashes 5 x.	The sensor receives too much IR-energy.	<ol style="list-style-type: none"> 1 Slightly increase the angle of the IR-curtains. 2 Decrease the IR-immunity filter (values 1-3 <2.8 m).
E5 		The sensor is disturbed by external elements.	<ol style="list-style-type: none"> 1 Eliminate the cause of disturbance (lamps, rain cover, door controller housing properly grounded).
E8 	ORANGE LED flashes 8 x.	IR power emitter is faulty.	<ol style="list-style-type: none"> 1 Replace sensor.
	ORANGE LED is on.	The sensor encounters a memory problem.	<ol style="list-style-type: none"> 1 Cut and restore power supply. 2 If orange LED lights up again, replace sensor.
	RED LED flashes quickly after an assisted setup.	The sensor sees the door during the assisted setup.	<ol style="list-style-type: none"> 1 Move the IR-curtains away from the door. 2 Install the sensor as close to the door as possible. If needed, use a bracket accessory. 3 Launch a new assisted setup.
	RED LED lights up sporadically.	The sensor vibrates.	<ol style="list-style-type: none"> 1 Check if the sensor is fastened firmly. 2 Check position of cable and cover.
		The sensor sees the door.	<ol style="list-style-type: none"> 1 Launch an assisted setup and adjust the IR angle.
		The sensor is disturbed by external conditions.	<ol style="list-style-type: none"> 1 Increase the IR-immunity filter to value 3. 2 Select presetting 2 or 3.
	GREEN LED lights up sporadically.	The sensor is disturbed by rain and/or leaves.	<ol style="list-style-type: none"> 1 Select presetting 2 or 3. 2 Increase radar-immunity filter.
		Ghosting created by door movement.	<ol style="list-style-type: none"> 1 Change radar field angle.
		The sensor vibrates.	<ol style="list-style-type: none"> 1 Check if the sensor and door cover is fastened firmly. 2 Check position of cable and cover.
		The sensor sees the door or other moving objects.	<ol style="list-style-type: none"> 1 Remove the objects if possible. 2 Change radar field size or angle.
	The LED and the LCD-display are off.		<ol style="list-style-type: none"> 1 Check wiring.
	The reaction of the door does not correspond to the LED-signal.		<ol style="list-style-type: none"> 1 Check output configuration setting. 2 Check wiring.
	The LCD or remote control does not react.	The sensor is protected by a password.	<ol style="list-style-type: none"> 1 Enter the right password. If you forgot the code, cut and restore the power supply to access the sensor without entering a password during 1 minute.

LED-SIGNAL



Motion detection



Presence detection



LED flashes



LED flashes x times



LED flashes red-green



LED flashes quickly



LED is off

INSTALLATION



The sensor should be fixed firmly to avoid extreme vibrations.

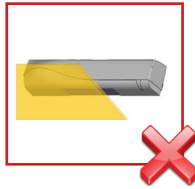

Do not cover the sensor.

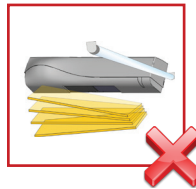

Avoid moving objects and light sources in the detection field.



Avoid highly reflective objects in the infrared field.

MAINTENANCE

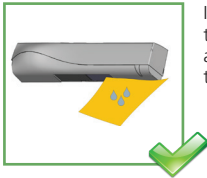

It is recommended to clean the optical parts at least once a year or more if required due to environmental conditions.



Do not use aggressive products to clean the optical parts.

SAFETY

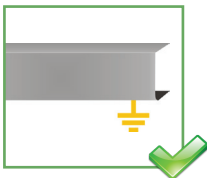

The door control unit and the door cover profile must be correctly earthed.



Only trained and qualified personnel may install and setup the sensor.



Always test the good functioning of the installation before leaving the premises.

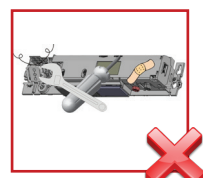

The warranty is invalid if unauthorized repairs are made or attempted by unauthorized personnel.



- The device cannot be used for purposes other than its intended use. All other uses cannot be guaranteed by the manufacturer of the sensor.
- The manufacturer of the door system is responsible for carrying out a risk assessment and installing the sensor and the door system in compliance with applicable national and international regulations and standards on door safety.
- The manufacturer of the sensor cannot be held responsible for incorrect installations or inappropriate adjustments of the sensor.

TECHNICAL SPECIFICATIONS

Supply voltage:	12 V - 24 V AC +/-10% ; 12 V - 30 V DC +/-10%	* The Equipment must be powered by a SELV limited power source ensuring double insulation between primary voltages and the Equipment supply. The supply current should be limited to max 3A.
Power consumption:	< 2.5 W	
Mounting height:	2 m to 4 m	
Temperature range:	-25°C to +55°C; 0-95% relative humidity, non condensing	
Degree of protection:	IP54	
Noise:	< 70 dB	
Expected lifetime:	20 years	



Detection mode:	Motion Min. detection speed: 5 cm/s	Presence Typical response time: < 200 ms (max. 500 ms)
Technology:	Microwave doppler radar Transmitter frequency: 24.150 GHz Transmitter radiated power: < 20 dBm EIRP Transmitter power density: < 5 mW/cm ²	Active infrared with background analysis Spot: 5 cm x 5 cm (typ) Number of spots: max. 24 per curtain Number of curtains: 2

Specifications are subject to changes without prior notice.
 All values are measured in specific conditions and with a temperature of 25°C.



BEA hereby declares that the IXIO-DO1 is in conformity with European directives 2014/53/EU (RED) and 2011/65/EU (RoHS).

The complete declaration of conformity is available on our website.



This product should be disposed of separately from unsorted municipal waste