

# LZR<sup>®</sup>-WIDESCAN

OPENING, PRESENCE & SAFETY\* SENSOR  
FOR INDUSTRIAL DOORS

Download the LZR WIDESCAN  
installation app!

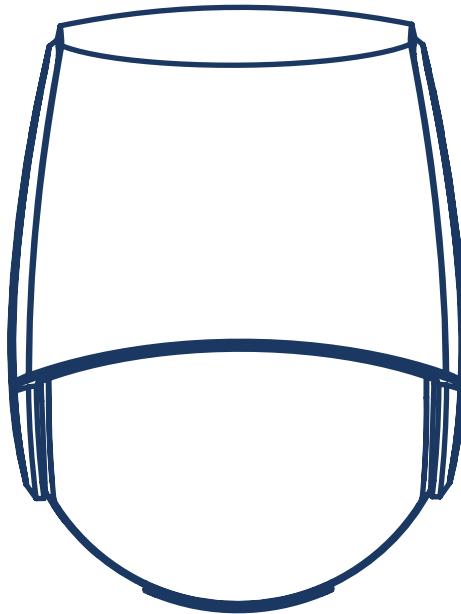

User's Guide for software version SW 0400 and higher  
(refer to tracking label on product)  
\* please refer to page 4

A Halma company



## INSTALLATION & MAINTENANCE TIPS

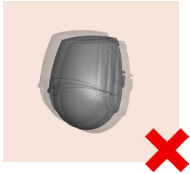

Avoid extreme vibrations.

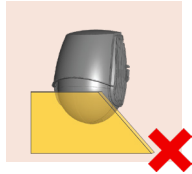

Do not cover the laser window screens.

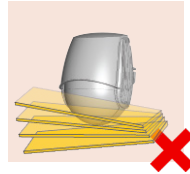

Avoid moving objects in the detection field.

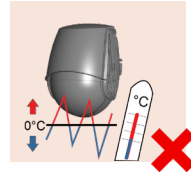

Avoid exposure to sudden and extreme temperature changes.

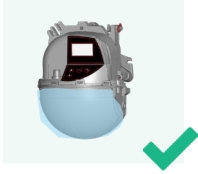

Keep the protection film during the mounting of the sensor. Remove it before launching a teach-in.

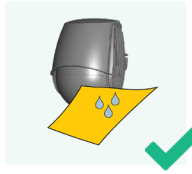

Wipe the laser window with a soft, clean and damp microfiber cloth. We recommend using optical lens cleaner.



Do not use aggressive products or dry towels to clean the optical parts.



Avoid direct exposure to high pressure cleaning.

## SAFETY PRECAUTIONS



The device emits invisible (IR) and visible laser radiations. The visible laser beams can be activated during the installation process to adjust the position of the detection field.

The visible laser beams are inactive during normal functioning. Do not stare directly into the visible laser beams.



### CAUTION!

Use of controls, adjustments or performance of procedures other than those specified herein may result in hazardous radiation exposure.

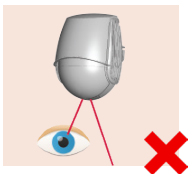

Do not stare directly into the visible laser beams.

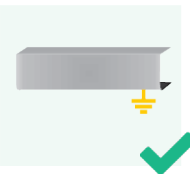

The metal base on which the sensor is mounted, must be correctly earthed.

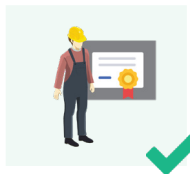

Only trained and qualified personnel may install and setup the sensor.



Always test the good functioning of the installation before leaving the premises.



The warranty is invalid if unauthorized repairs are made or attempted by unauthorized personnel.



- The device cannot be used for purposes other than its intended use. All other uses cannot be guaranteed by the manufacturer of the sensor.
- The manufacturer of the door system is responsible for installing the sensor and the door system in compliance with applicable national and international regulations.
- The manufacturer of the sensor cannot be held responsible for incorrect installations or inappropriate adjustments of the sensor.

## DESCRIPTION

The LZR®-Widescan is an industrial door sensor with opening and presence features.

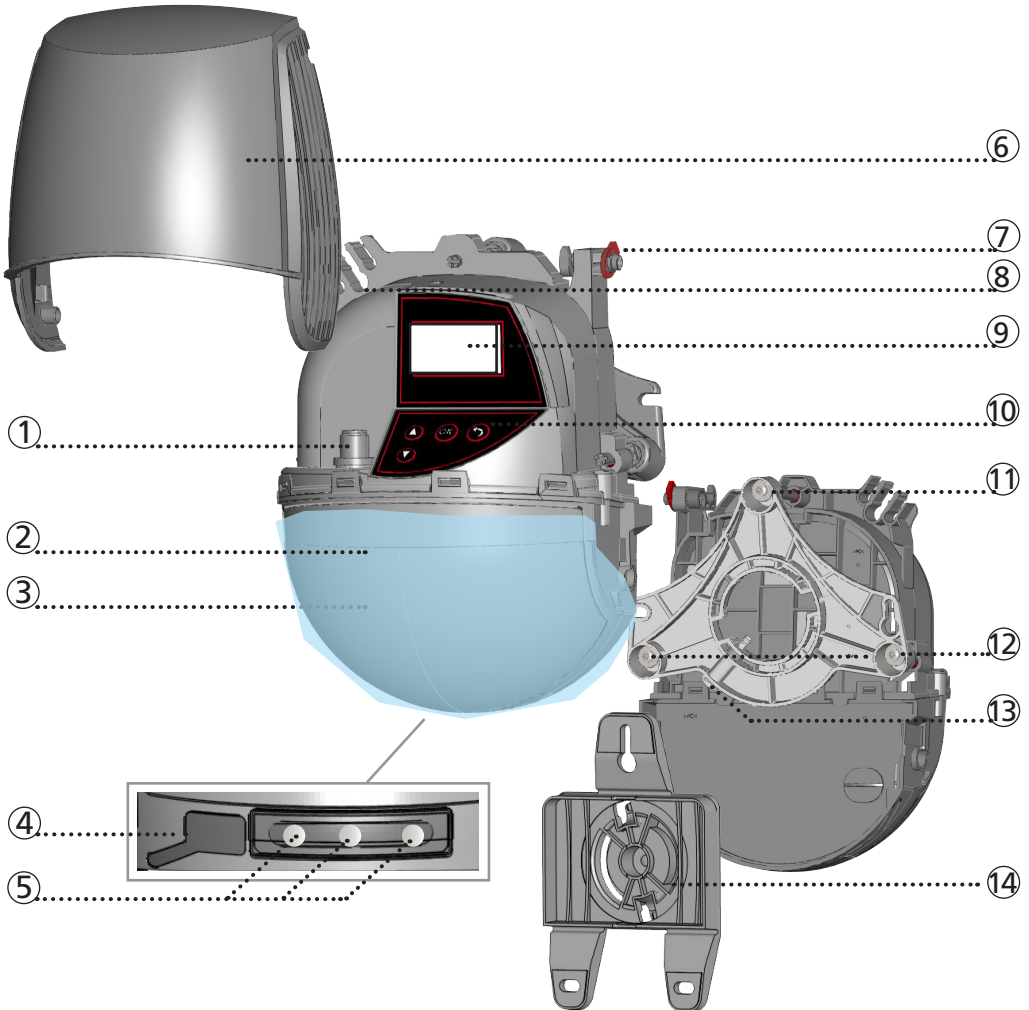



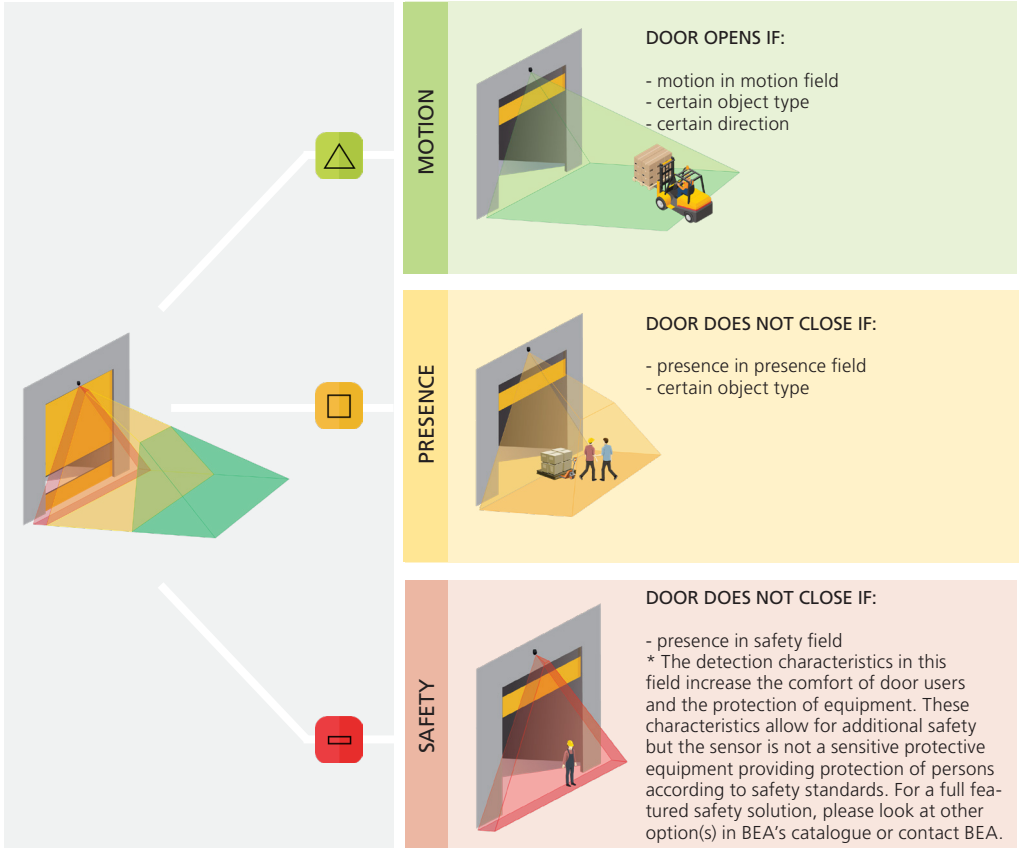

- |    |                 |     |                                      |
|----|-----------------|-----|--------------------------------------|
| 1. | main connector  | 8.  | cable passage                        |
| 2. | protection film | 9.  | LCD-screen                           |
| 3. | laser window    | 10. | keypad                               |
| 4. | USB cap         | 11. | tilt angle adjustment screw (1x)     |
| 5. | LED-display     | 12. | parallel angle adjustment screw (2x) |
| 6. | cover           | 13. | lateral angle lock screw (1x)        |
| 7. | cover lock      | 14. | mounting bracket                     |

## BASIC PRINCIPLES: FUNCTIONS & OBJECT

There are 3 main functions that create **3 overlapping detection fields** with certain detection characteristics each:



There are 4 additional functions. All detection functions can be combined to trigger a specific output (see output functions on page 16).

-  Motion +: assignment of an other moving object type for the motion field
-  Virtual pull cord: detection of an object standing still in a learned pull cord zone
-  Speed: detection of an object moving below a defined speed
-  Height: presence detection of an object exceeding a defined height

The sensor carries out a 3D-object analysis and detects depending on the following characteristics: height, width & depth.

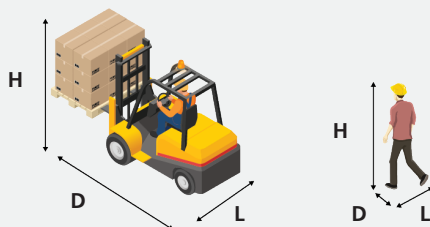

## LED-SIGNAL



### SETTINGS

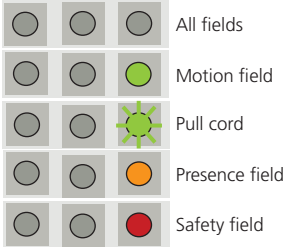

### DETECTION

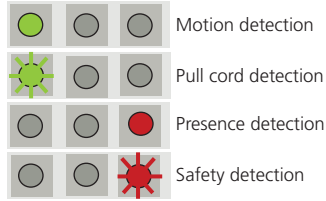

### GENERAL

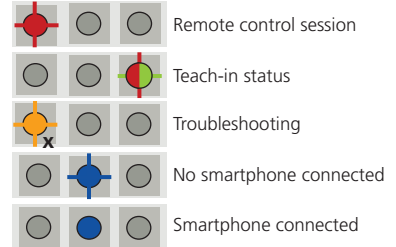

## SYMBOLS



### MAIN FUNCTIONS:



### ADDITIONAL FUNCTIONS:



## OPENING THE SENSOR

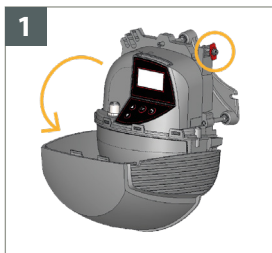

Before opening the sensor, make sure the cover is **not locked** (red cover lock).

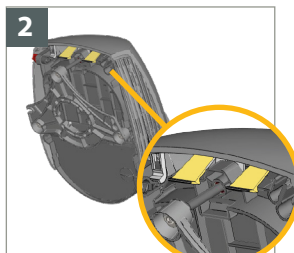

To open the top cover, pull both flags while tilting the cover away from its initial position.

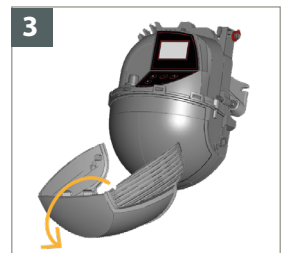

If needed, remove the cover completely before installing the sensor.

## HOW TO ADJUST THE SENSOR BY REMOTE CONTROL



After unlocking, the red LED flashes and the sensor can be adjusted by remote control.



If the red LED flashes quickly after unlocking, enter an access code from 1 to 4 digits. If you do not know the access code, **cut and restore the power supply**. During 1 minute, you can access the sensor without any code.



To end an adjustment session, always lock the sensor.

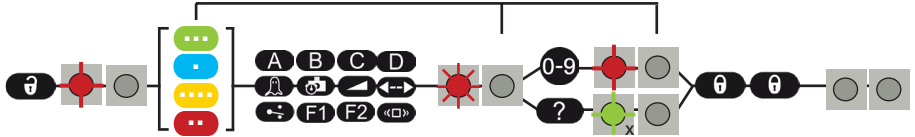

If necessary, select first the corresponding detection field before pushing on the parameter and changing the value. The second LED indicates the detection field.

x = number of flashes = value of the parameter

2x 1x 3x 1x 5x = field width: 2.35 m

- ... MOTION
- . PULL CORD
- .... PRESENCE
- .. SAFETY

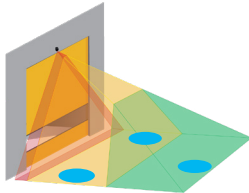

Activate red spots	
Teach-in: install	0
Teach-in: pull cord	1 / 2 / 3
Presettings	3 / 4 / 5
Restoring to factory values	8 / 9

## HOW TO ADJUST THE SENSOR BY LCD



Enter the LCD-menu.  
Select a folder, parameter or value.  
Confirm a value and exit edit mode.



Activate red spots on floor.



Launch CENTRE TOOL for correct positioning of detection field (see p. 8).



Select to return to previous menu or display.



Scroll up or down the menu items or values.



Select your **Language** before entering the first LCD-menu.  
*During the first 30 seconds after power-on of the sensor or later in the diagnostics menu.*



Enter a **Password** if necessary.  
«Specific» menu password: 1234



Select **More** to access advanced adjustments.

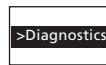

Select **Diagnostics** to go to the diagnostics menu



Displayed value = factory value



Displayed value = saved value

# 1a MOUNTING & WIRING



Mounting height: as high as possible in acc. to the limitations in the Technical specifications  
The size of the detection field depends on the mounting height.

Mounting position: **centre of door or upper left corner.**  
Mounting on the right side of the door should be avoided.

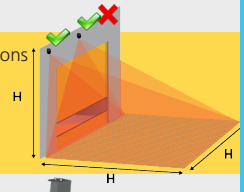

The UNIVERSAL MOUNTING BRACKET can be used if the environment requires it.

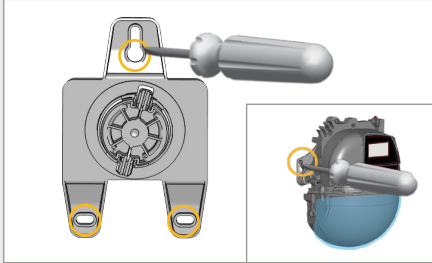

Screw the mounting bracket on the wall. You can also install the sensor directly without using the mounting bracket.

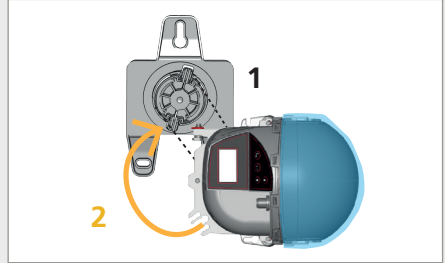

Position the sensor on the mounting bracket and turn as shown to click into place.

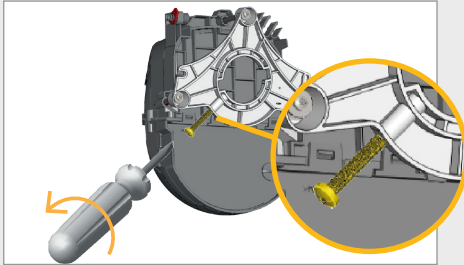

Unscrew the angle lock screw if necessary.

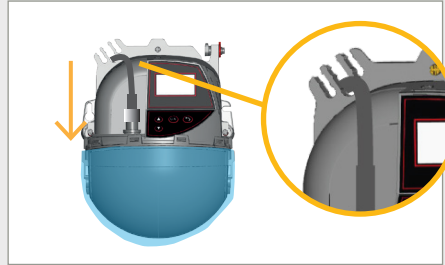

Plug the connector and pass the cable through the cable passage without making a loop.

		POWER
*		OUT 1**
*		OUT 2**
*		RELAY**
		TEST

Connect the wires.

\*\*The output functions can be configured if necessary, see p. 16.

\* Output status when in non detection.



Teach-in reminder



Push OK to return to detection display.

## 1b POSITIONING OF DETECTION FIELD

First of all, remove the blue protection film from the laser window.

- !** If the sensor is mounted **in the center of the door**, follow steps **1 3 4** and **6** to adjust the field.  
If the sensor is mounted **on the left (or right side\*)**, follow all steps described on this page.

\* Note that right side mounting could alter the performance of the motion detection

PARALLEL ANGLE

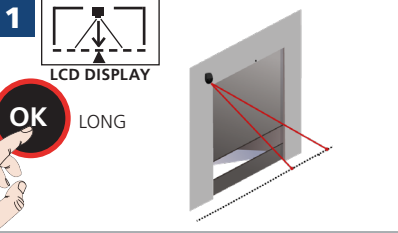

Push long on OK to enter the CENTRE-TOOL and activate the visible spots.

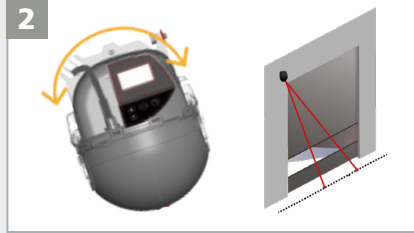

Rotate the sensor in order to align the centre of the red spots with the centre of the door.

TILT ANGLE

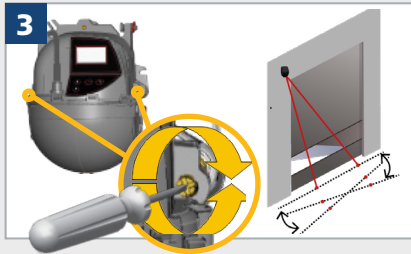

Make sure the curtain is **parallel** to the door by adjusting one or both screws on the side.

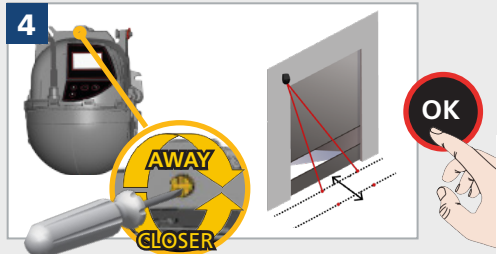

Position the curtain **closer to or further away** from the door by turning the screw at the top. Push OK to confirm.

LATERAL ANGLE

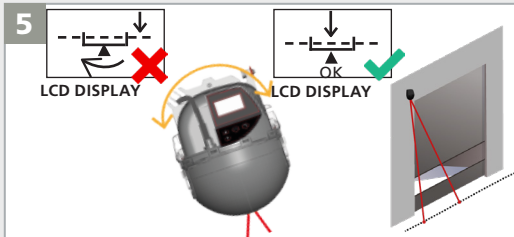

Look at the CENTER-TOOL on the LCD display. Rotate the sensor until both arrows on the LCD screen are aligned. **The visible spots must now be off-center for the detection field to cover the whole door symmetrically!**

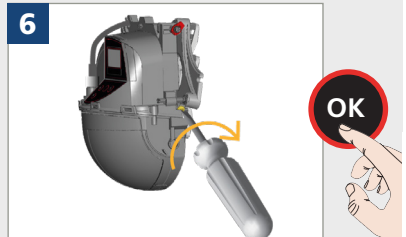

Carefully lock the sensor position by firmly fastening the angle lock screw. Make sure the red spots have not moved. Push OK to exit and deactivate the visible spots.

## 1c CLOSING THE SENSOR

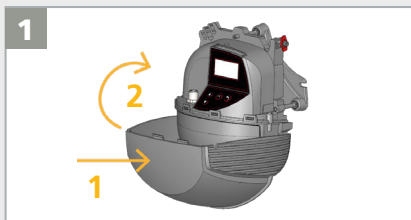

1. Slightly spread the cover and clip it **horizontally**.  
2. Close the cover.

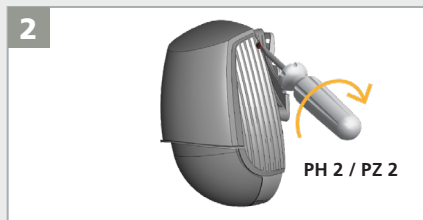

Lock the cover by turning the lock screw clockwise.



## 2 TEACH-IN: INSTALL



- Make sure the blue protection film is removed and the sensor is closed!
- Make sure the laser window is free from dust and/or water drops.
- The teach-in zone (square in front of the 2 visible spots) must be empty and even. If not, see troubleshooting.
- This teach-in must be launched each time a sensor's position/orientation has been changed.

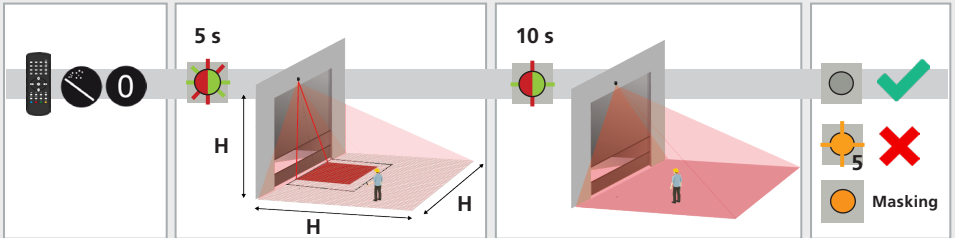

Launch a teach-in by remote control.

The teach-in starts after 5 seconds. The teach-in zone must be empty and even!

Wait while position, angle and height are learned and the background is analysed.

The teach-in is finished. If not ok see troubleshooting.

## 3 PRESETTINGS

Choose one of the following presettings. They adjust a number of parameters automatically according to your application. If necessary, you can also adjust a parameter independently via remote control (see p. 10).

(**Bold** = differs from factory settings)

### STANDARD



- open space
- traffic from and to all directions
- storage right and/or left



field width: max, field stop: max  
object type: **vehicle**  
direction: **uni CTR +**



field width: max, field stop: 3 m  
object type: **vehicle**  
max presence time: 30 min



field width: max, field stop: 0.4 m  
(infinite detection for objects > 25 cm)

OUT1 motion or pull cord

OUT2 presence or safety

REL presence + height

### CORRIDOR

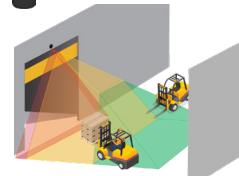

- confined space
- traffic from and to all directions
- no storage



field width: max, field stop: max  
object type: **vehicle**  
direction: uni CTR



field width: max, field stop: **2 m**  
object type: **vehicle**  
max presence time: **infinite**



field width: max, field stop: 0.4 m  
(infinite detection for objects > 25 cm)

OUT1 motion or pull cord or **safety**

OUT2 presence or safety

REL **speed trigger**

### CORNER



- corner
- no parallel traffic
- storage right and/or left



field width: max, field stop: max  
object type: **vehicle**  
direction: **uni**



field width: max, field stop: 3 m  
object type: **vehicle**  
max presence time: 30 min



field width: max, field stop: 0.4m  
(infinite detection for objects > 25 cm)

OUT1 motion or pull cord or **presence**

OUT2 presence or safety

REL presence + height

# OVERVIEW OF REMOTE CONTROL SETTINGS (OPTIONAL)

		0	1	2	3	4	5	6	7	8	9		
		<p>0 1 2 3 4 5 6 7 8 9</p>											
Teach-in		install											
Presettings		STD corridor corner											
Service Mode		The service mode deactivates the presence and safety detection during 15 minutes and can be useful during an installation, a mechanical teach-in of the door or maintenance work. Exit the service mode by using the same sequence.											
Factory Reset		full: complete reset of all values partial: reset of all values except IN/OUT											
Red spots		Activates the red spots on the floor. The spots stay active during 15 minutes or can be switched off the same way.											
<b>MOTION</b>													
C	Field width	000 - 999	000 - 999	000 - 999	000 - 999	999	cm	The max. reachable dimensions will automatically adapt acc. to mounting conditions					<p>DOOR</p> <p>B</p> <p>C</p> <p>D</p>
D	Field depth (stop)	000 - 999	000 - 999	000 - 999	000 - 999	999	cm	000 cm = red spots' position					
B	Field start	000 - 999	000 - 999	000 - 999	000 - 999	000	cm						
Object type		vehicle XL (WH): detects large vehicles; rejects bicycles & narrow forklifts vehicle: detects all types of vehicles; rejects pedestrians any: detects all objects					vehicle XL (WH)	vehicle	any				
Direction			uni CTR				away	uni CTR+		uni			
Immunity		1	2	3	4								
		CTR: cross traffic rejection INV: inverted											
<b>PULL CORD</b>													
Teach-in		# 1	# 2	# 3									
Object type		pedestrian						vehicle XL (WH)	vehicle	any			
Min. presence time		0 s	1 s	2 s	3 s	4 s	5 s	6 s	7 s	8 s	stop		
		pedestrian: detects pedestrians only vehicle XL (WH): detects large vehicles; rejects bicycles & narrow forklifts vehicle: detects all types of vehicles; rejects pedestrians any: detects all objects											
<b>PRESENCE</b>													
C	Field width	000 - 999	000 - 999	000 - 999	000 - 999	999	cm	The max. reachable dimensions will automatically adapt acc. to mounting conditions					<p>DOOR</p> <p>B</p> <p>C</p> <p>D</p>
D	Field depth (stop)	000 - 999	000 - 999	000 - 999	000 - 999	300	cm	000 cm = red spots' position					
B	Field start	000 - 999	000 - 999	000 - 999	000 - 999	000	cm						
Object type		vehicle XL (WH): detects large vehicles; rejects bicycles & narrow forklifts vehicle: detects all types of vehicles; rejects pedestrians any: detects all objects					vehicle XL (WH)	vehicle	any				
Immunity		1	2	3	4	5							
Max presence time		30 s	1 min	2 min	5 min	10 min	30 min	60 min	120 min	infinite			
<b>SAFETY</b>													
C	Field width	000 - 999	000 - 999	000 - 999	000 - 999	999	cm	The max. reachable dimensions will automatically adapt acc. to mounting conditions					<p>DOOR</p> <p>B</p> <p>C</p> <p>D</p>
D	Field depth (stop)	000 - 999	000 - 999	000 - 999	000 - 999	040	cm						
Immunity		1	2	3	4	5							

# OVERVIEW OF REMOTE CONTROL SETTINGS (OPTIONAL)

	0	1	2	3	4	5	6	7	8	9													
<b>F1</b> Out 1 Function	no change	motion	mot or pull	mot/pull/safe	mot/pull/pres	pull cord	motion+	motion+ & height	motion+ & speed		<b>OUT1 OUT2 REL</b> <table border="1"> <tr> <td><b>F1</b></td> <td>1</td> <td>0</td> <td>6</td> </tr> <tr> <td></td> <td>4</td> <td>0</td> <td>1</td> </tr> <tr> <td></td> <td>1</td> <td>1</td> <td>3</td> </tr> </table> <p>Always enter 3 digits for output parameters:                      - 1st digit refers to output 1                      - 2nd to output 2                      - 3rd to the relay</p> <p>See p. 16-17 for more info on output functions.</p>	<b>F1</b>	1	0	6		4	0	1		1	1	3
<b>F1</b>	1	0	6																				
	4	0	1																				
	1	1	3																				
<b>F1</b> Out 2 Function	no change	presence	safety	pres/safety	presence & height																		
<b>F1</b> Relay Function	no change	motion	pull cord	presence	safety	motion+	height	speed	pres & height	pres/safety													
Entering 0 keeps the value unchanged.																							
Out 1 Logic*	no change			NO	NC	freq 100 Hz**																	
Out 2 Logic*	no change			NO	NC	PWM																	
Relay Logic*	no change	passive	active																				
Out 1 Holdtime	100 ms	1 s	3 s	5 s	10 s	30 s	1 min	5 min	10 min	20 min													
Out 2 Holdtime	100 ms	1 s	3 s	5 s	10 s	30 s	1 min	5 min	10 min	20 min													
Relay Holdtime	100 ms	1 s	3 s	5 s	10 s	30 s	1 min	5 min	10 min	20 min													

FACTORY VALUES

\* output status when in non detection  
 \*\* during non-detection

To save an access code via the remote control :



To delete an access code via the remote control :



**A/E** Field shift :  
 (Always verify the detection area after changing this parameter)



**C** Without selecting a colour key, you adjust the width of all 3 detection fields (motion, presence & safety) at the same time.

**Heating function via LCD:** Quick Start > More > Heating



Choose **AUTO** to continuously remove condensation on the laser window (higher power consumption).

**QR-code via LCD:** Diagnostics > QR-code



To quickly send an overview of all selected values, scan the QR-code on the LCD-screen using your smartphone scanner app. If needed use the flashlight of your phone to improve contrast. A string of digits will be visible on your phone. Send this string via email to our technical support team.

# MOTION





**FIELD WIDTH**   **C** **0** **0** **0** - **9** **9** **9**

000 cm (no field) - 999 cm



**FIELD DEPTH**   **D** **0** **0** **0** - **9** **9** **9**

000 cm - 999 cm





**OBJECT TYPE**   **7** **8** **9**

vehicle XL (WH)    vehicle    any

vehicle XL (WH): detects large vehicles; rejects bicycles & narrow forklifts  
 vehicle: detects all types of vehicles; rejects pedestrians  
 any: detects all objects

**DIRECTION**   **1** **2** **6** **7** **9**

bi    uni CTR    uni INV    uni CTR+    uni

ANY		bidirectional detection approaching and going away	<b>1</b>
UNI		unidirectional detection approaching in any direction (distance between object and sensor decreases)	<b>9</b>
UNI CTR (100%)		unidirectional detection approaching with cross traffic rejection	<b>2</b>
UNI CTR + (100% +)		unidirectional detection approaching with cross traffic rejection + 1 m in front of door : bidirectional detection without cross traffic rejection	<b>7</b>
AWAY		unidirectional detection with inversion only going away	<b>6</b>

## PRESENCE

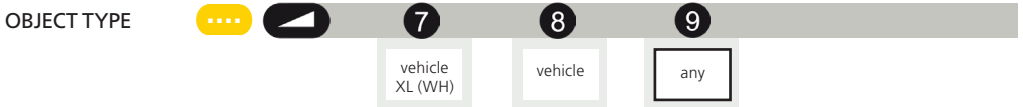
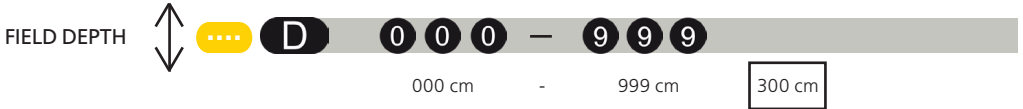
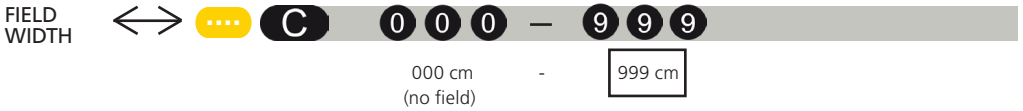

vehicle XL (WH): detects large vehicles; rejects bicycles & narrow forklifts  
 vehicle: detects all types of vehicles; rejects pedestrians  
 any: detects all objects

## SAFETY

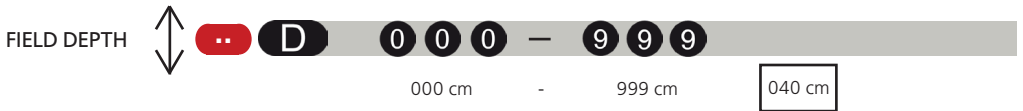
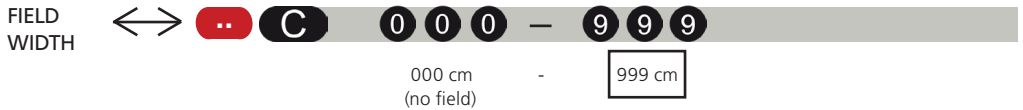

# VIRTUAL PULL CORD



The door only opens when an object is detected in one of the three virtual pull cord zones during the chosen min. presence time (factory value : 2 seconds).

In order to use this function:

- the sensor must know its environment: teach-in install is OK.
- the corresponding wires must be connected to the door activation input (out 1 by default)
- the output or relay function must be set to motion or pull cord (factory value) or pull cord.

To create a virtual pullcord:

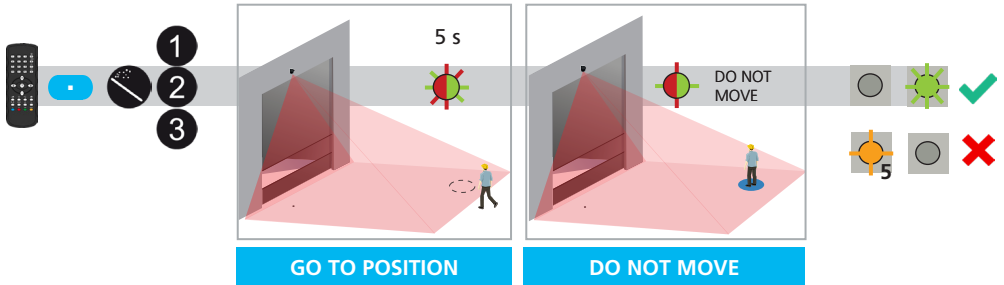

Launch a pull cord teach-in by remote control. You can create 3 different pull cords in the scanned area.

Go to the position where you want to activate the door by a virtual pull cord. The LED quickly flashes red-green during 5 seconds.

The learning process starts, please do not move. The LED slowly flashes red-green.

The teach-in process is finalized. The LED quickly flashes green or is out.

If flashing orange see troubleshooting.

Make sure there is nothing in the scanned area !

If the LED flashes green, stop moving.

By remote control you can choose the object type and its minimum presence time to activate the door:

**OBJECT TYPE**

1 pedestrian
7 vehicle XL (WH)
8 vehicle
9 any

pedestrian: detects pedestrians only  
 vehicle XL (WH): detects large vehicles; rejects bicycles & narrow forklifts  
 vehicle: detects all types of vehicles; rejects pedestrians  
 any: detects all objects

**MIN. PRESENCE TIME**

0 0 s
1 1 s
2 2 s
3 3 s
4 4 s
5 5 s
6 6 s
7 7 s
8 8 s
9 stop

0 s: immediate activation  
 stop: only a complete stop of the object activates the door

To delete the virtual pull cord zone, simply relaunch a pull cord teach-in without standing in the scanning zone. After 1 minute the sensor flashes 5x orange. Push unlock + lock to exit the adjustment mode:

## HEIGHT TRIGGER

All objects higher than 2.25 m will activate the selected output.



This option is typically used to open the door completely or partially depending on the height of the object. The wiring and logic of the output configuration are related to the door controller.

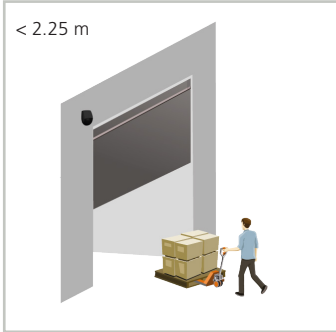

The door opens partially  
(motion detection - out 1)

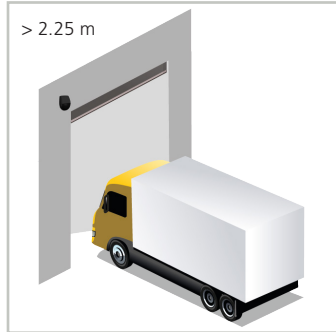

The door opens completely  
(height detection - relay)

You can adjust the minimum height limit via LCD: Others > Height min. (1.75 - 4 m)

## SPEED TRIGGER

All objects moving slower than 5 km/h will activate the selected output.



This option is typically used in confined areas with no frontal traffic and is included in the presetting «corridor».

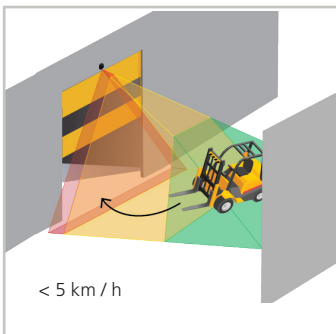

The door opens.

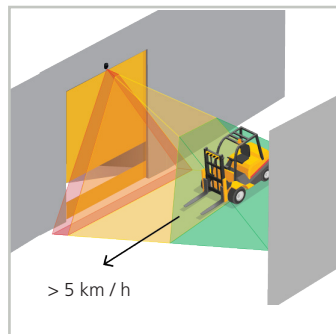

The door stays closed.

You can adjust the maximum speed limit via LCD: Others > Speed max. (5 - 50km/h)

## OUT 1

### DOOR ACTIVATION FUNCTIONS



1	Motion		
2	Motion or pull cord		
3	Motion or pull cord or safety		
4	Motion or pull cord or presence		
5	Pull cord		
6	Motion +		
7	Motion + and height		
8	Motion + and speed		

## OUT 2

### PROTECTION FUNCTIONS



1	Presence		
2	Safety		
3	Presence or safety		
4	Presence and height		

## RELAY

### ADDITIONAL FUNCTIONS (OPTIONAL)

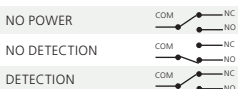

1	Motion		
2	Pull cord		
3	Presence		
4	Safety		
5	Motion +		
6	Height		
7	Speed		
8	Presence and height		
9	Presence or safety		

Example : **F1** OUT 1 OUT 2 RELAY

<b>5</b>	<b>2</b>	<b>0</b>
pull cord	safety	no change
<b>1</b>	<b>0</b>	<b>7</b>
motion	no change	speed

FACTORY VALUES





## CHOSEN SETTINGS

DATE : ..... DATE : ..... DATE : ..... DATE : .....



LOCATION : ..... LOCATION : ..... LOCATION : ..... LOCATION : .....

INSTALLER : ..... INSTALLER : ..... INSTALLER : ..... INSTALLER : .....



### MOVEMENT

<b>C</b> Field width				
<b>D</b> Field depth (stop)				
<b>B</b> Field start				
 Object type				
 Direction				
 Immunity				

### PULL CORD

 Teach-in				
 Object type				
 Min. presence time				

### PRESENCE

<b>C</b> Field width				
<b>D</b> Field depth (stop)				
<b>B</b> Field start				
 Object type				
 Immunity				
 Max presence time				









### SAFETY

<b>C</b> Field width				
<b>D</b> Field depth (stop)				
 Immunity				

<b>F1</b> Out 1 Function				
<b>F1</b> Out 2 Function				
<b>F1</b> Relay Function				



## TROUBLESHOOTING

E1		E1: CPU-XXX	The sensor encounters an internal problem.	!	Replace sensor.
E2		E2: XXX PWR	The internal power supply is faulty.	!	Replace sensor.
		E2: IN SUPPLY	The power supply is too low or too high.	1	Verify power supply > Diagnostics - LCD.
		E2: TEMP	The internal temperature is too low or too high.	1	Verify the sensor temperature > Diagnostics - LCD.
E4		E4: FRONT MASKING door remains open for 5 min. at each opening	The sensor might be blinded.	1	Clean the front face.
				2	Remove masking object.
E5			The sensor requests a teach-in.	1	Launch teach-in after angle adjustment. All presence/safety-outputs are activated.
		E5: FLATNESS	Faulty teach-in.	1	Make sure the teach-in zone is empty and even.
				2	Launch install teach-in:
				3	If zone is clear on the left, select: 
					If zone is clear on the right, select:
		E5: TILT	Faulty teach-in because of tilt angle.	1	Adjust tilt angle (max. 15° > Diagnostics - LCD).
				2	Launch install teach-in.
E5: AZIMUTH	Faulty teach-in because of lateral angle.	1	Adjust lateral angle (max. 45° > Diagnostics - LCD)		
		2	Launch install teach-in.		
E5: HEIGHT	Faulty teach-in because of mounting height.	1	Adjust mounting height (max. 6 m, min. 2 m)		
		2	Launch install teach-in.		
E5: TIME-OUT	Faulty teach-in because of movement in the detection field.	1	Launch install teach-in. Make sure there is no motion detection during at least 5 seconds when the LED starts flashing red-green.		
		2	Slightly change your position and relaunch install teach-in.		
E6		E6: FQ OUT	Faulty sensor output 1.	!	Replace sensor.
E8		E8: ...	Faulty detection engine.	1	If temperature is lower than -20°C, wait until the heating process is completed.
				2	If not, replace sensor.
		ORANGE LED is on.	The sensor encounters a memory problem	!	Replace sensor.
		ORANGE LED is on during 3 sec. (masking)	Sensor placed in a corner and perpendicular to a wall	1	Tilt the sensor to shift the detection field
			Masking: obstacle high up in front of the door	2	Reduce the number of curtains by LCD (Quick start > More > Nb curtains).
		The LED and the LCD-display are off.		1	Check wiring.
				2	Check pinning and connection on sensor side.
		The door does not react.	The service mode is activated.	1	Exit the service mode (see p. 10)
		The product does not react to the remote control.	The sensor is protected by a password.	1	Enter the right password. If you forgot the code, cut and restore the power supply to access the sensor without entering a password during 1min.
		The motion detection starts too late.	The sensor has a big negative angle.	1	Reduce the angle of the sensor.

## TECHNICAL SPECIFICATIONS

<b>Technology</b>	LASER scanner, time-of-flight measurement (7 laser curtains)
<b>Detection mode</b>	Motion, presence, height and speed
<b>Max. detection field</b>	Width: 1 x mounting height; Depth: 1 x mounting height
<b>Thickness of first curtain</b>	0.5 cm / m (mounting height)
<b>Mounting height</b>	2 m to 10 m
<b>Min. reflectivity factor</b>	> 2 % (of floor and object) (measured at max. 6 m in safety field)
<b>Min. object size</b>	70 cm x 30 cm x 20 cm
<b>Emission characteristics</b> (IEC 60825-1)	IR LASER: Wavelength 905 nm; output power <0.1 mW; Class 1 Visible LASER: Wavelength 635 nm; output power <1 mW; Class 2
<b>Bluetooth communication</b>	Operating bandwidth: 2402 MHz – 2480 MHz Maximum transmitted power: 12 dBm
<b>Supply voltage</b>	12 V - 24 V AC -10%/+20% ; 12 V - 30 V DC -10%/+20% @ sensor terminal (The Equipment must be powered by an approved Class II SELV limited power source. This requirement consists of the need for double insulation between primary voltages and the Equipment supply. The supply current should be limited to 1.5 A)
<b>Power consumption</b>	heating off: < 2.5 W heating auto: typ. < 10 W, max. 15 W
<b>Response time</b>	Typ. 230 ms; max. 800 ms (depending on immunity settings)
<b>Output</b>	2 solid-state relays (galvanic isolation - polarity free) 24 V AC/ 30 V DC (max. switching voltage) - 100 mA (max. switching current) - in switching mode: NO/NC - in frequency mode: pulsed signal (f= 100 Hz +/- 10%) 1 electro-mechanic relay (galvanic isolation - polarity free) 42 V AC/DC (max. switching voltage) - 500 mA (max. switching current)
<b>Test input</b>	30 V DC (max. switching voltage) - low < 1 V, high > 10 V (voltage threshold)
<b>LED-signals</b>	3 coloured LEDs
<b>Dimensions</b>	159 mm (H) x 208 mm (W) x 127 mm (D)
<b>Material / Colour</b>	PC/ASA / Black
<b>Rotation angles on bracket</b>	45° to the right, 15° to the left (lockable)
<b>Tilt angles on bracket</b>	-10° to +5°
<b>Protection degree</b>	IP65
<b>Temperature range</b>	-30 °C to +60 °C

*Specifications are subject to change without prior notice.  
All values measured in specific conditions.*

THIS USER'S GUIDE IS AN INFORMATIVE DOCUMENT AND CAN NOT BE SEEN AS A COMMITMENT OF RESULT.

BEA | A-B Area, 3rd Floor | No.1 Building, No.5 Xinghai Road, Beijing Economic Technological Development Area, Beijing | China  
T +86 10 57761630 / F +86 10 62628775 / E info-as@beasensors.com / W asia.beasensors.com



BEA hereby declares that the LZR®-WIDESCAN is in conformity with directives RED 2014/53/EU and RoHS2 2011/65/EU.  
The complete declaration of conformity is available on our website.



This product should be disposed of separately from unsorted municipal waste.

