

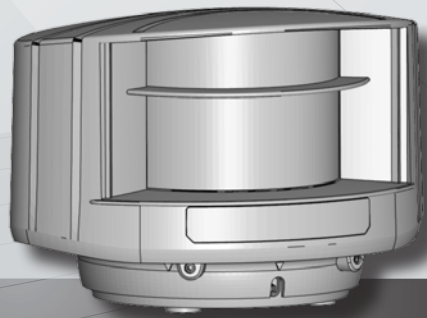

EN



LZR[®] - U905

LASER MEASUREMENT DEVICE

LASER MEASUREMENT DEVICE

Other use of the device is outside the permitted purpose and can not be guaranteed by the manufacturer. The manufacturer cannot be held responsible for incorrect installations or inappropriate adjustments of the sensor.

DESCRIPTION

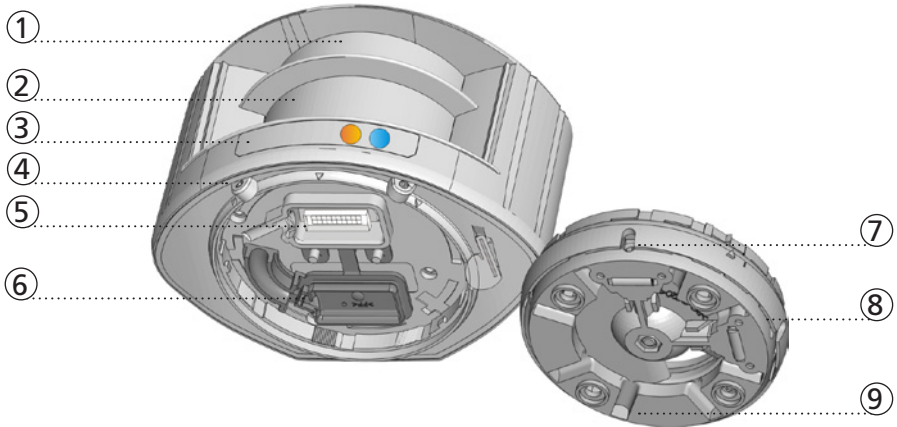

- | | |
|--------------------------------|--|
| 1. laser sweep emission | 6. protection cover |
| 2. laser sweep reception | 7. notch for tilt angle adjustment (2) |
| 3. LED-signal (2) | 8. adjustable bracket |
| 4. screw for position lock (2) | 9. cable conduit (4) |
| 5. connector | |

LED-SIGNAL



ERROR LED



error

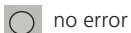

no error

POWER LED



power



no power

SAFETY

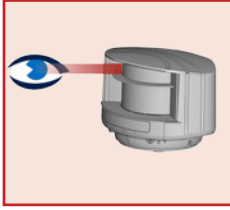

Do not look into the laser emitter.

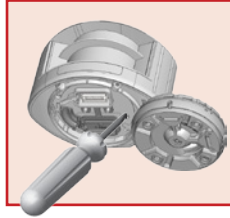

The warranty is void if unauthorized repairs are made or attempted by unauthorized personnel.



Only trained and qualified personnel may install and adjust the sensor.



CAUTION!

Use of controls, adjustments or performance of procedures other than those specified herein may result in hazardous radiation exposure.

INSTALLATION AND MAINTENANCE

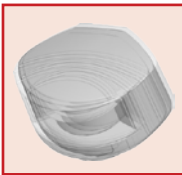

Avoid extreme vibrations.

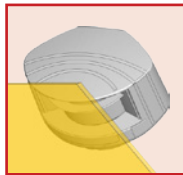

Do not cover the front screens.

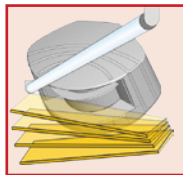

Avoid moving objects and light sources in the detection field.

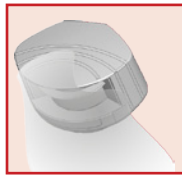

Avoid the presence of smoke and fog in the detection field.

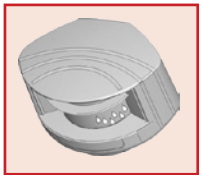

Avoid condensation.

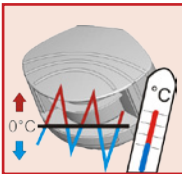

Avoid exposure to sudden and extreme temperature changes.



Avoid direct exposure to high pressure cleaning.



Do not use aggressive products to clean the front screens.

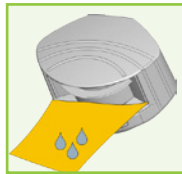

Wipe the front screens regularly with a clean and damp cloth.

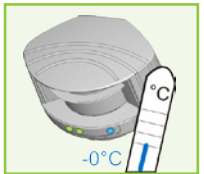

Keep the sensor permanently powered in environments where the temperature can descend below 0°C.

1 MOUNTING

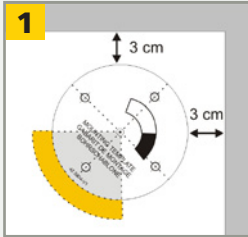

Use the adhesive mounting template to position the sensor correctly. The grey area indicates the detection range.

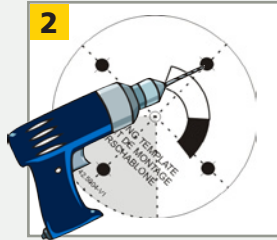

Drill 4 holes as indicated on the mounting template. Make a hole for the cable if possible.



Pass the cable +/- 10 cm through the cable opening.

If drilling an opening is not possible, use the cable conduits on the back side of the bracket.



Position the bracket and fasten the 4 screws firmly.



Open the protection cover, plug the connector and position the cable in the slit.

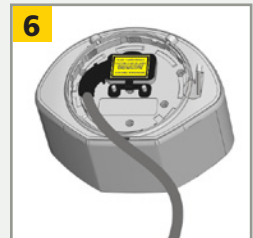

Close the protection cover and fasten it firmly.

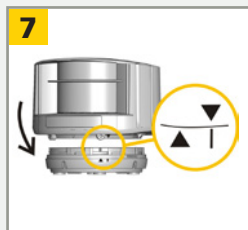

Position the housing on the bracket.

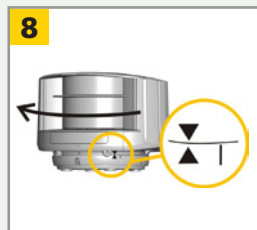

Turn the sensor until the two triangles are face to face.

2 WIRING

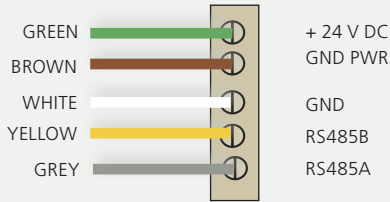

3 POSITIONING

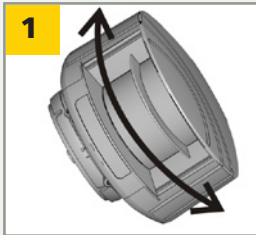

Adjust the **lateral position** of the detection field.

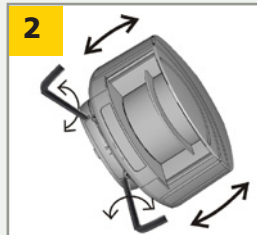

Adjust the **tilt angle** of the detection field with the hex key.

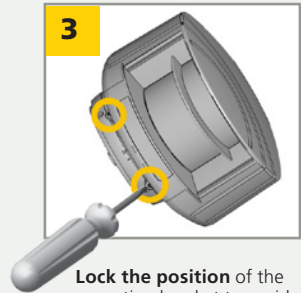

Lock the position of the mounting bracket to avoid malfunctioning in case of extreme vibrations.

TECHNICAL SPECIFICATIONS

Technology:	laser scanner, time-of-flight measurement
Measurement range:	max 65 m 9 m @ 2% remission factor
Number of planes:	4
Number of points/plane:	274
Angular resolution:	0.3516 °
Angular coverage:	96.3281 °
Rotating speed:	900 turns/min
Remission factor:	> 2 %
Laser emission characteristics:	wavelength 905 nm; max. output pulse power 75 W (CLASS 1)
Supply voltage:	10-35 V DC @ sensor side
Power consumption:	< 5 W
Peak current at power-on:	1.8 A (max. 80 ms @ 35 V)
Serial communication:	see application note LZR®-90X Protocol (available for download on our website)
Type	asynchronous
Interface	RS 485
Communication mode	half-duplex
Transmission speed	460800 bit/sec
Topology	point to point
Symbol coding	1 start bit, 1 stop bit, no parity bit
File type	8 bits
LED-signal:	1 blue LED: power-on status; 1 orange LED: error status
Dimensions:	125 mm (D) x 93 mm (W) x 70 mm (H) (mounting bracket + 14 mm)
Material:	PC/ASA
Colour:	black
Mounting angles on bracket:	-45 °, 0 °, 45 °
Rotation angles on bracket:	-5 ° to +5 ° (lockable)
Tilt angles on bracket:	-3 ° to +3 °
Protection degree:	IP65
Temperature range:	-30 °C to +60 °C if powered; -10 °C to +60 °C unpowered
Humidity:	0-95 % non-condensing
Vibrations:	< 2 G
Pollution on front screens:	max. 30 %; homogenous
Expected lifetime:	8 years
Norm conformity:	2006/95/EC: LVD; 2002/95/EC: RoHS; 2004/108/EC: EMC EN 50155:2007; EN 60529:2001; IEC 60825-1:2007 Laser Class 1; EN 60950-1:2005 EN 61000-6-2:2005 EMC - Industrial level EN 61000-6-3:2006 EMC - Commercial level

Specifications are subject to changes without prior notice.
All values measured in specific conditions.

TROUBLESHOOTING



No blue LED

There is no power.

1 Check cable and connexion.

The polarity of the power supply is inverted.

1 Check the polarity of the power supply.



The orange LED is on.

The power supply voltage is exceeding the acceptable limits.

1 Check the power supply voltage.

The sensor exceeds its temperature limits.

1 Verify the outside temperature where the sensor is installed. Eventually protect the sensor from sunlight using a cover.

Internal error

1 Wait a few seconds.
If the LED remains ON, reset the power supply.
If the LED turns on again, replace the sensor.

NOTES



A DIVISION OF BEA SA | LIEGE SCIENCE PARK | ALLÉE DES NOISETIERS 5 - 4031 ANGLEUR [BELGIUM]
T +32 4 361 65 89 | F +32 4 361 28 58 | INFO@SENSORIO.BE | WWW.SENSORIO.BE



BEA hereby declares that the LZR®-U905 is in conformity with the basic requirements and the other relevant provisions of the directives 2006/95/EC, 2002/95/EC and 2004/108/EC.

Angleur, April 2012
Jean-Pierre Valkenberg, authorized representative
The complete declaration of conformity is available on our website: www.sensorio.be



EC countries: according to the directive 2002/96/EC for Waste Electrical and Electronic Equipment (WEEE)