

# Quick Start

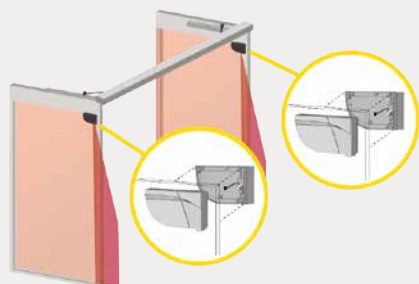

SLAVE

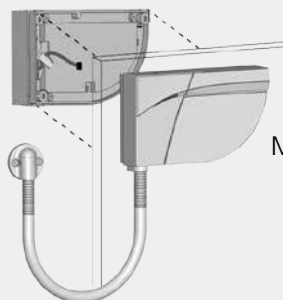

MASTER

## 1 MOUNTING ON DOOR

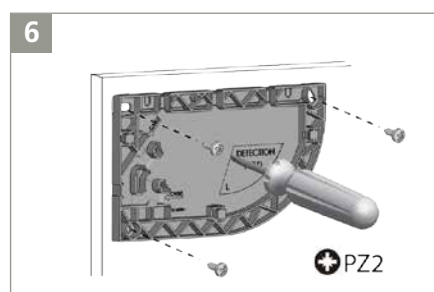
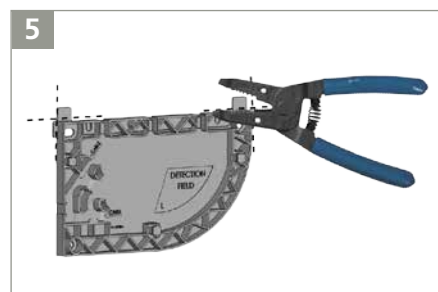
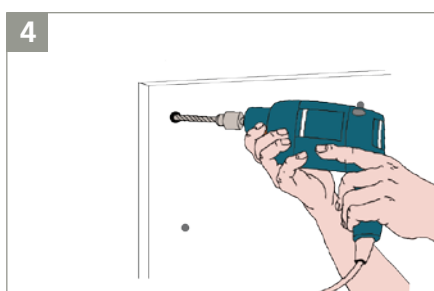
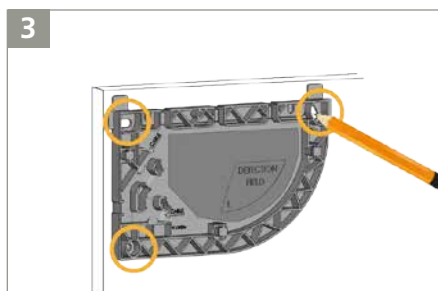
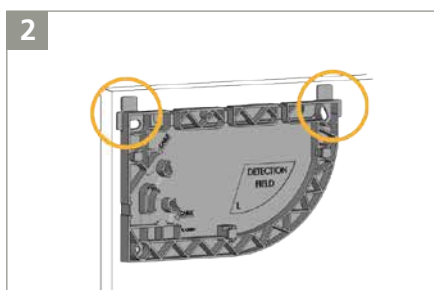
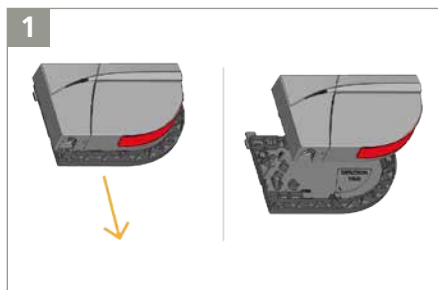

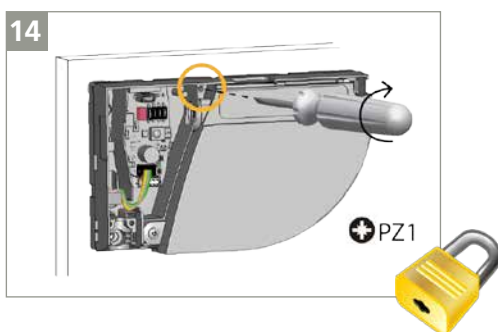
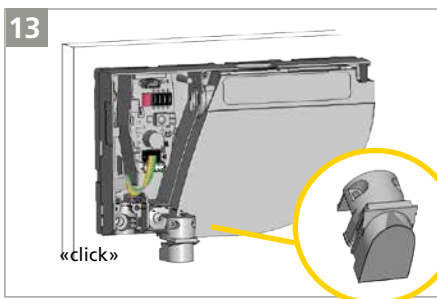
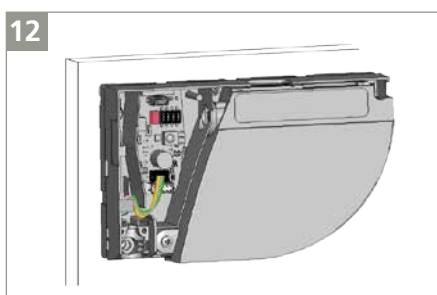
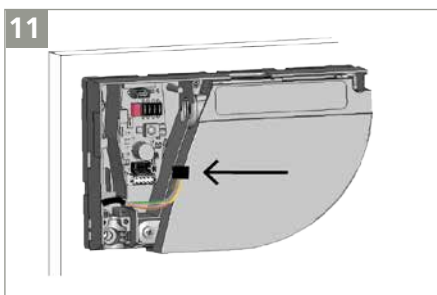
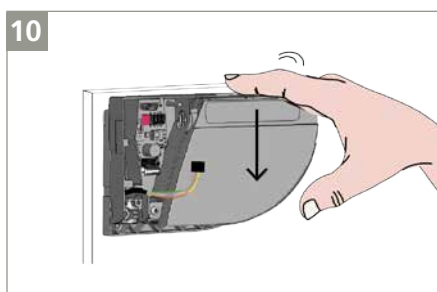
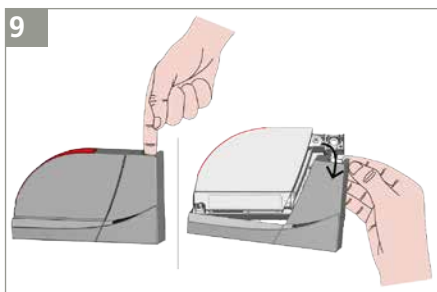
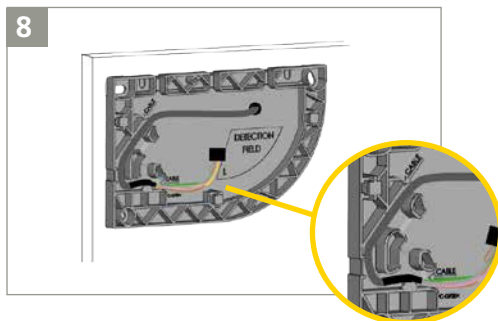
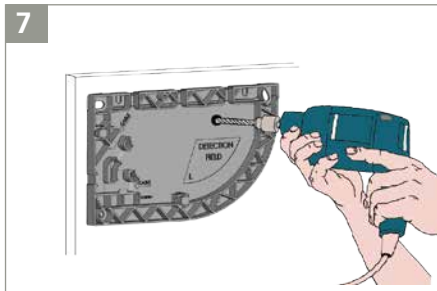

## 2 WIRING TO DOOR CONTROLLER

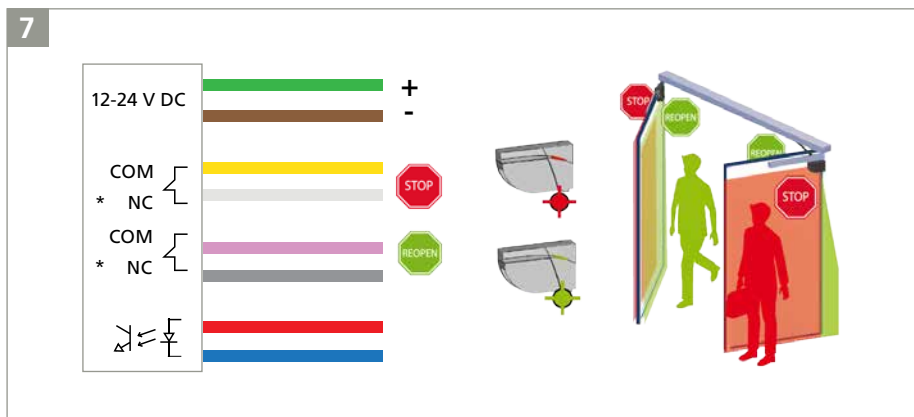
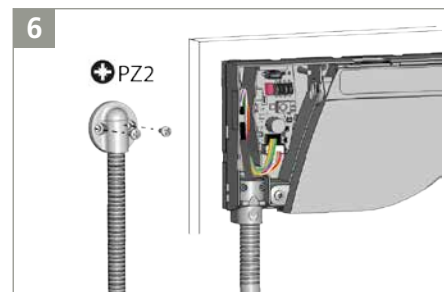
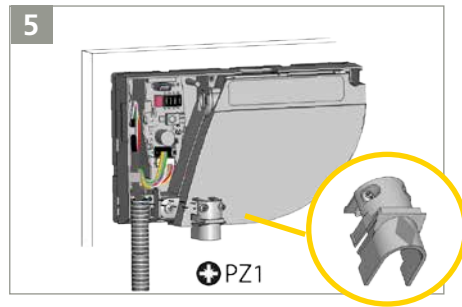
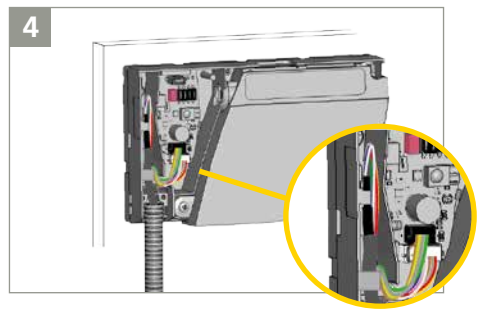
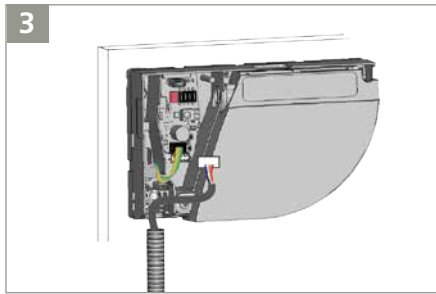
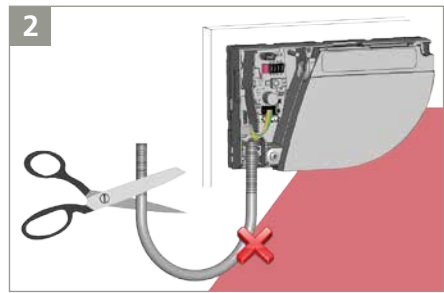
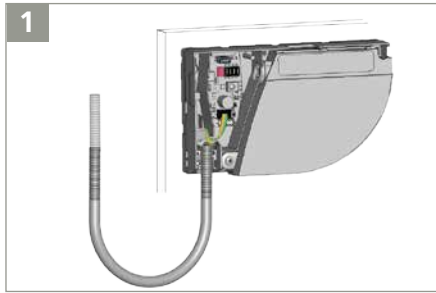

### 3 DIP1

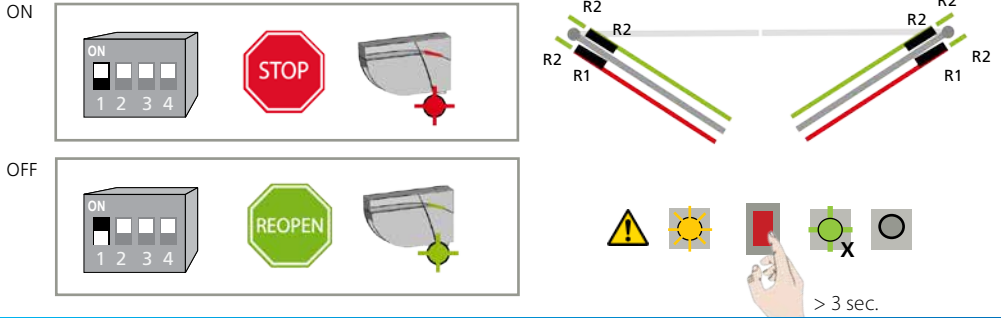

### 4 TEACH-IN

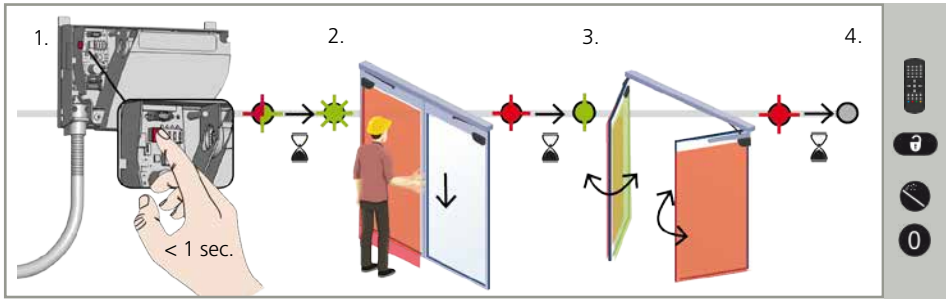

### 5 TEST + ADJUSTMENTS

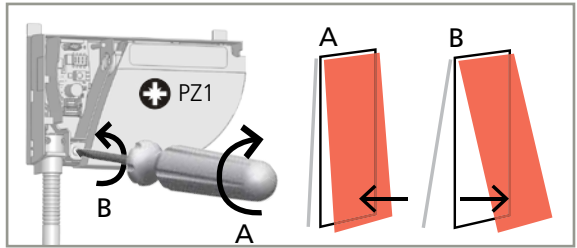

### 6 FINAL STEPS

